

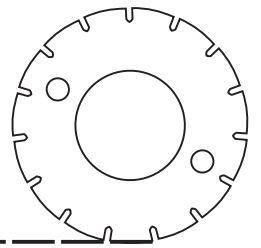

**KEPES,
Inc.**

7/8" I.D. *PERFS*

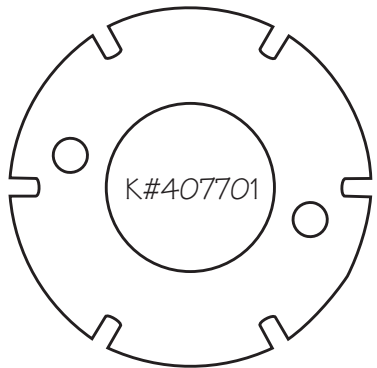

 <p>K#407701</p> <p>CUT <u>7/8"</u> (.875) GAP <u>3/32"</u> (.094) TEETH <u>6</u> T.P.I. <u>1.45</u></p>	 <p>K#430113 (use #408017 holding collar)</p> <p>CUT <u>9/32"</u> (.281) GAP <u>5/32"</u> (.156) TEETH <u>12</u> T.P.I. <u>1.45</u></p>	 <p>K#407702</p> <p>CUT <u>3/8"</u> (.375) GAP <u>3/32"</u> (.094) TEETH <u>12</u> T.P.I. <u>2</u></p>
 <p>K#407708</p> <p>CUT <u>5/16"</u> (.313) GAP <u>1/16"</u> (.063) TEETH <u>15</u> T.P.I. <u>2.5</u></p>	 <p>K#407703</p> <p>CUT <u>1/4"</u> (.25) GAP <u>1/16"</u> (.063) TEETH <u>18</u> T.P.I. <u>3</u></p>	 <p>K#407704</p> <p>CUT <u>5/32"</u> (.156) GAP <u>3/32"</u> (.094) TEETH <u>24</u> T.P.I. <u>4</u></p>
 <p>K#407705</p> <p>CUT <u>3/32"</u> (.094) GAP <u>3/32"</u> (.094) TEETH <u>31</u> T.P.I. <u>5.25</u></p>	 <p>K#407706</p> <p>CUT <u>5/64"</u> (.078) GAP <u>1/162"</u> (.063) TEETH <u>41</u> T.P.I. <u>7</u></p>	 <p>K#407707</p> <p>CUT <u>3/64"</u> (.046) GAP <u>3/64"</u> (.064) TEETH <u>64</u> T.P.I. <u>11</u></p>

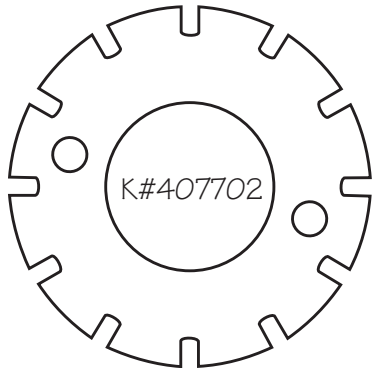
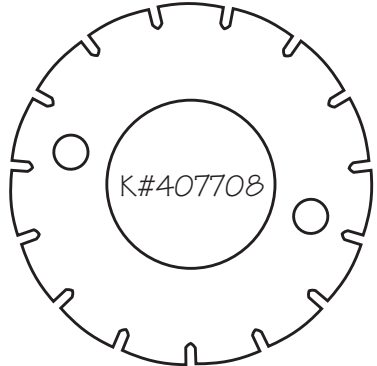
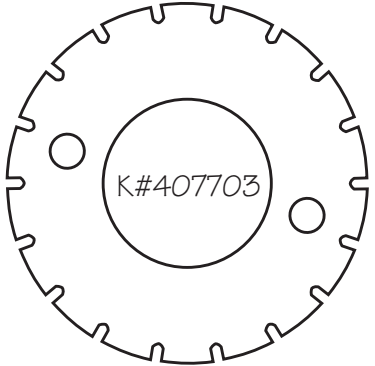
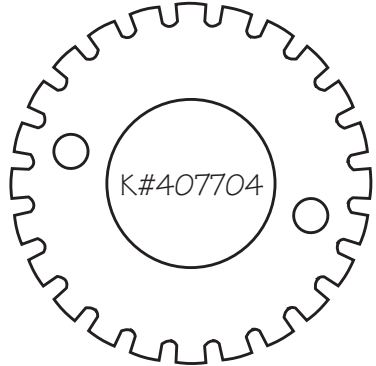
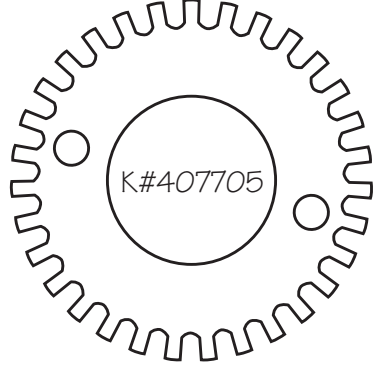
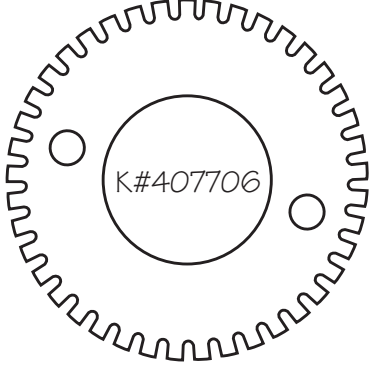
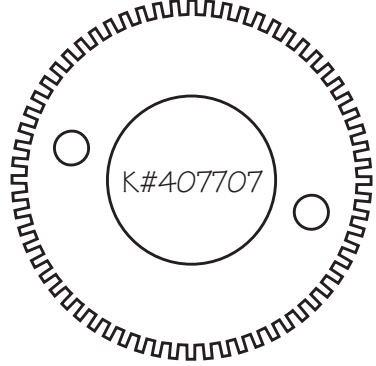
9016 58 Place, Suite 600
(262) 652-7889

www.kepes.com

Kenosha, WI 53144
Fax (262) 652-7787

SCORES, SLITTERS, AND ACCESSORIES

7/8" I.D. SLITTERS

KEPES SLITTER PART #	A WIDTH INCHES	B COUNTERSUNK FLAT SIDE	C COUNTERSUNK BEVEL SIDE
407603	1/16	YES	YES
407801	3/32	YES	NO
407802	3/32	NO	YES
407803	1/16	YES	NO
407804	1/16	NO	YES
407805	1/16	YES	NO
407806	1/16	NO	YES

PLEASE NOTE: 407805, 407806 Deep Bevel

7/8" I.D. SCORES

K#407880 1/16" wide
K#407881 1/8" wide

ACCESSORIES
CLAMP
#810001

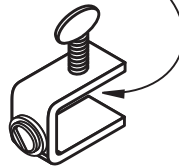

SLOTTED PERF STRIPPER FINGER (stripper only) #409003

EDGE TRIM STRIPPER (complete) #430046 RIGHT #430027 LEFT (right shown)

STRIPPER (only) #409200

TIRE ONLY #407001

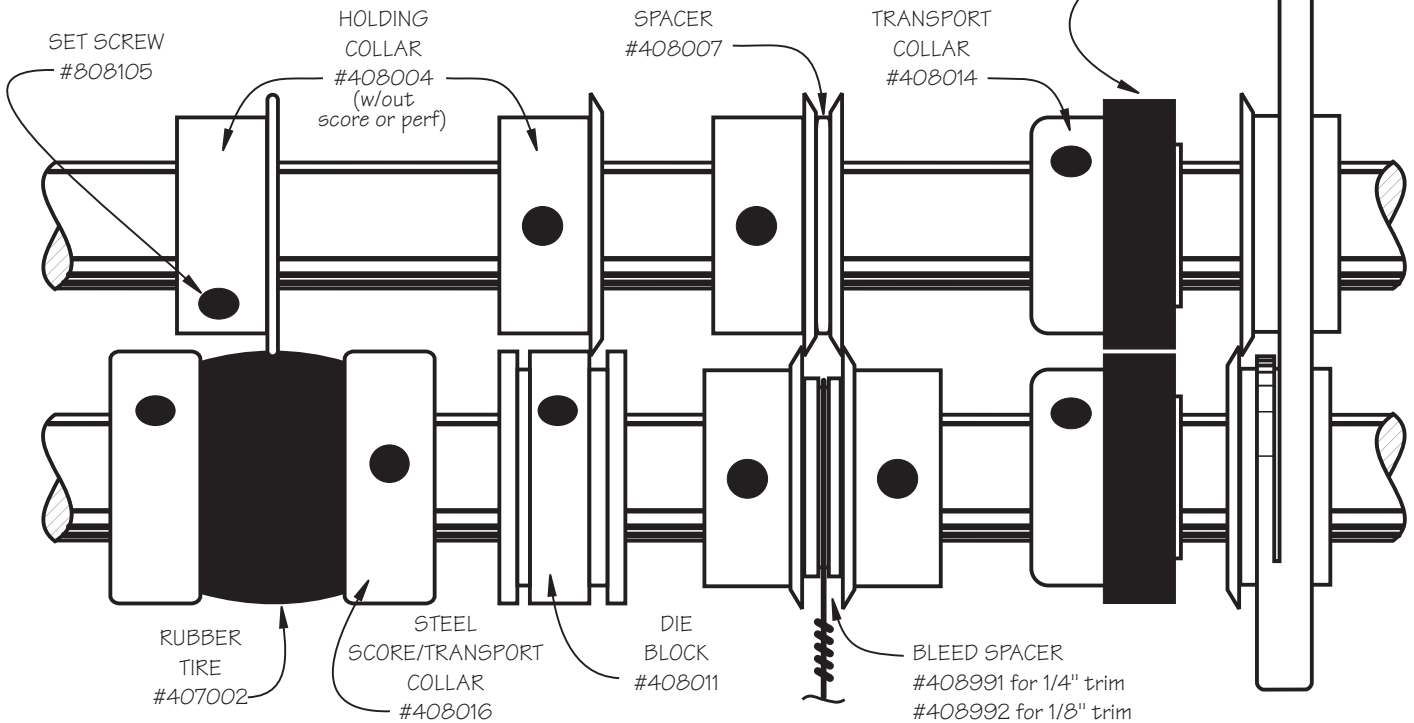

MOST PARTS ARE IN STOCK AND CAN BE SHIPPED THE SAME DAY!!!